

**BRINKMANN®**

**OWNER'S MANUAL**

**TWO BURNER PROPANE  
CAMPING STOVE**

**⚠ WARNING**

**FAILURE TO FOLLOW ALL WARNINGS  
AND INSTRUCTIONS IN THIS MANUAL  
COULD LEAD TO PERSONAL INJURY,  
INCLUDING DEATH.**

RETAIN THIS MANUAL FOR  
FUTURE REFERENCE.

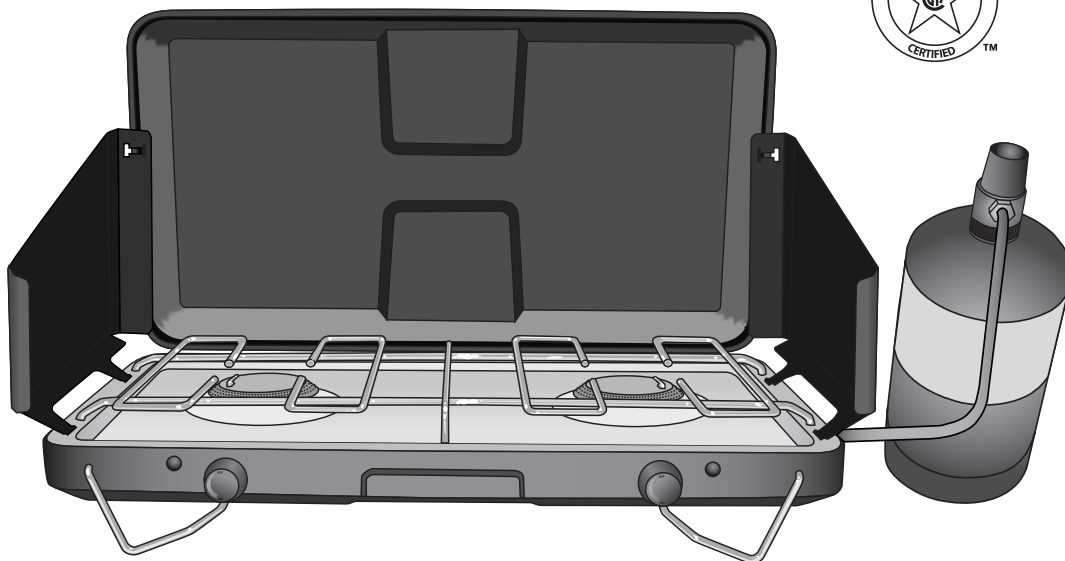

Propane cylinder not included.

### FOR YOUR SAFETY:

#### IF YOU SMELL GAS:

1. **DO NOT** attempt to light appliance.
2. Extinguish any open flame.
3. Disconnect from fuel supply.

### FOR YOUR SAFETY:

**DO NOT** store or use gasoline or other liquids with flammable vapors in the vicinity of this or any other appliances.



## DANGER

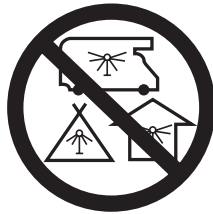

### CARBON MONOXIDE HAZARD

This appliance can produce carbon monoxide which has no odor.

Using it in an enclosed space can kill you.

Never use this appliance in an enclosed space such as a camper, tent, car or home.

## IMPORTANT SAFETY WARNINGS

### **⚠ WARNING**

- **FOR OUTDOOR USE ONLY. DO NOT** operate indoors (house, tent, garage) or in any unventilated or enclosed area.
- All burning appliances consume oxygen. This stove uses oxygen from the air and may produce CO (Carbon Monoxide), which is a colorless, odorless gas that can kill you. Ample ventilation must be provided to avoid endangering your life. Be certain that the area in which this appliance is used is properly ventilated at all times.
- **DO NOT** use as a space heater.
- **DO NOT** leave stove unattended when hot or in use. Only adults are to operate this stove; keep children and pets safely away. Carefully monitor all activity around stove to avoid burns or other injuries.

## **⚠ WARNING**

- **DO NOT** operate stove within 36" from any combustible material including walls and ceiling.
- **DO NOT** use on/in apartment complex balconies or patios, recreational vehicles, campers or boats.
- Propane gas is extremely flammable, follow these instructions:
  - **DO NOT** store or use gasoline or other liquids/aerosols with flammable vapors in the vicinity of this appliance.
  - Use only 14.1 oz. or 16.4 oz. LP-gas cylinder(s) constructed and marked in accordance with the specifications for LP-gas cylinders of the United States Department of Transportation (DOT) or Transport Canada, CAN/CSA 339. **DO NOT** use fuel other than propane.
  - Always attach or detach propane cylinder outdoors away from flame, pilot lights or other sources of ignition and only when appliance is cool to touch.
  - Read and follow all warnings and instructions on or accompanying propane cylinder.
  - Always inspect appliance, propane cylinder and propane connections for damage, dirt or debris before attaching propane cylinder. **DO NOT** use if either has been damaged or modified.
  - Follow directions in the "**Gas Leak Testing**" section on page 4 of this manual. Never test for gas leaks with a lit match or open flame. **DO NOT** operate the stove with a gas leak.
  - When transporting, not using, or storing stove always disconnect propane cylinder.
  - Propane cylinder should remain upright to prevent liquid propane flare-up.
  - **DO NOT** connect to a remote gas supply such as natural gas or a refillable propane cylinder.
- In case of fire, turn gas "OFF" at burner control knobs and use Type 'BC' fire extinguisher or other appropriate means to extinguish flame.
- Keep hands, face and hair away from burners. Use long matches or long-nosed lighter to light the burners. **DO NOT** wear loose clothing or allow long hair to hang freely while lighting or using stove.
- Always snap down legs to form a "V" with the stove base to prevent the stove from becoming unstable while in use. Use only on a flat surface
- **DO NOT** move stove while in use. Avoid touching hot surfaces.
- Use only supplied regulator A200-0 (Brinkmann part number 450-A200-0).
- Only use replacement/accessory parts manufactured by The Brinkmann Corporation. Repairs should be performed by The Brinkmann Corporation. For parts or repairs contact The Brinkmann Corporation's Customer Service Department at 800-527-0717.
- Properly dispose of all packaging materials.

# ASSEMBLY INSTRUCTIONS

**▲ READ ALL SAFETY WARNINGS & ASSEMBLY INSTRUCTIONS CAREFULLY BEFORE ASSEMBLING OR OPERATING YOUR STOVE.**

*Inspect contents of the box to ensure all parts are included and undamaged.*

**FOR MISSING PARTS, PLEASE CALL CUSTOMER SERVICE AT 800-527-0717.**

*(Proof of purchase will be required.)*

**Step 1**

Snap down legs to form a "V" with the stove base.

**Step 2**

Open lid and align the two wind guards by inserting notched support arms into wind guards.

**Step 3**

Remove regulator assembly from under grill inside stove. Replace grill. Make sure burner control knobs are in "OFF" position.

**Step 4**

Attach regulator assembly to stove fitting. **HAND TIGHTEN ONLY.** Do not cross-thread connections.

**Step 5**

Attach propane cylinder to regulator assembly by turning propane cylinder counter-clockwise. **HAND TIGHTEN ONLY.** Do not cross-thread connections.

**▲ CAUTION:** Turn cylinder so that it is almost upright, slanted slightly towards you. The cylinder does not sit flat on surface. See diagram below.

**Step 6**

Follow "Gas Leak Testing" instructions on page 4 of this manual.

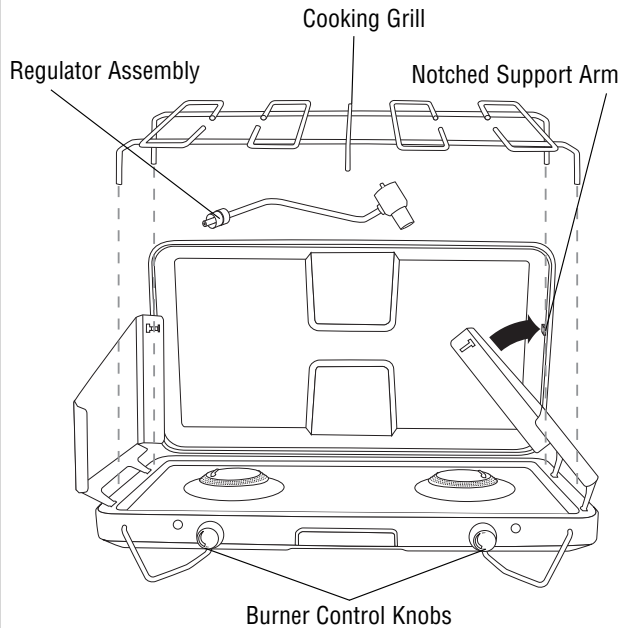

**▲ WARNING:** Always snap down legs to form a "V" with the stove base to prevent the stove from becoming unstable while in use.

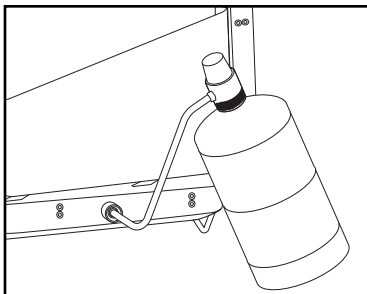

**NOTE:** Propane canister slants slightly towards front of stove.

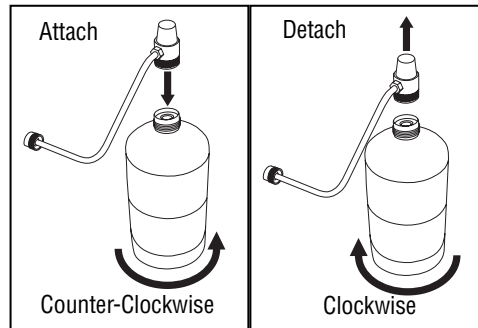

## GAS LEAK TESTING

### ⚠ WARNING

- Gas leak testing must be performed outdoors in a well ventilated area every time cylinder is connected to stove.
- Always keep unit away from open flames, sparks or lit cigarettes.
- Never use a flame to check for gas leaks.
- The control knobs are used when lighting the burners and to adjust the flame.
- Never use a unit that has a gas leak. Contact The Brinkmann Corporation's Customer Service Department for replacement parts or repairs at 800-527-0717.

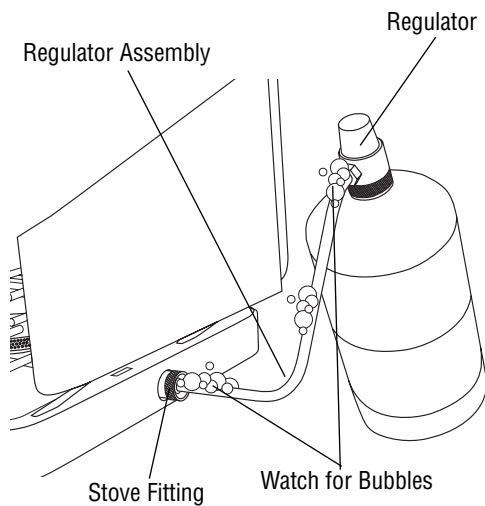

#### Step 1

Assemble stove per "**Assembly Instructions**" on page 3 of this manual. Make sure burner control knobs are in "OFF" position.

#### Step 2

Prepare a soapy water solution (one part dishwashing liquid to three parts water) to test for gas leaks in the connections. Apply a generous amount of the soapy mixture to the regulator assembly at the regulator and stove fitting (located on the right side of stove).

#### Step 3

With the burner control knobs in the "OFF" position, check for bubbles where propane canister attaches to regulator assembly and at stove fitting. If soapy mixture starts bubbling, gas is leaking through the connections. Disconnect the propane canister. Retighten the connection that is leaking gas. Repeat procedure with soapy mixture until gas no longer leaks. **NEVER USE A FLAME TO CHECK FOR GAS LEAKS.**

#### Step 4

Once all gas leaks have been sealed, **WAIT AT LEAST 5 MINUTES FOR GAS FUMES TO DISSIPATE BEFORE LIGHTING THE BURNERS.**

Carefully follow "**Operating Instructions**" to light the burner and properly operate this unit.

# OPERATING INSTRUCTIONS

**⚠ READ ALL SAFETY WARNINGS AND INSTRUCTIONS CAREFULLY.**

## ⚠ WARNING

- **DO NOT** allow gasoline or other flammable vapors or liquids to come in contact with stove while lighting or at any time during use of stove.

### Step 1

Make sure "**Gas Leak Testing**" from page 4 was completed and the burner control knobs are in the "OFF" position and stove is on a flat surface away from combustible material.

### Step 2

Decide which burner to light first. Using a long match, hold the flame beside burner. Turn the burner control knob **SLOWLY** counter-clockwise until the burner lights.

- ⚠ WARNING:** If the burner does not light within 5 seconds, turn the burner control knobs "OFF" immediately. Wait at least 5 minutes until gas fumes have dissipated before attempting to light burner again.

### Step 3

To light the second burner, reduce the flame on the first lit burner and repeat Step 2 to the other burner.

- ⚠ WARNING:** If second burner does not light within 5 seconds, turn the burner control knobs "OFF" immediately. Wait at least 5 minutes until gas fumes have dissipated before attempting to light burner again.

### Step 4

Adjust burner flame as necessary by using burner control knob. Turn stove "OFF" using burner control knobs when stove is not in use.

### Step 5

Allow stove to cool completely, then follow instructions in the "**After-Use Safety**" and "**Proper Care & Maintenance**" sections of this manual.

Minimum clearance to combustibles 36 inches from top and side of stove burners

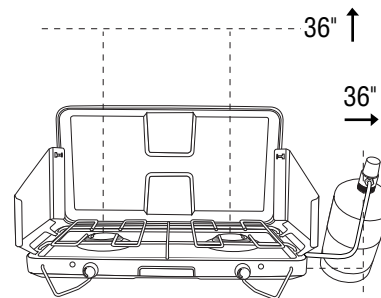

Perimeter of base of stove

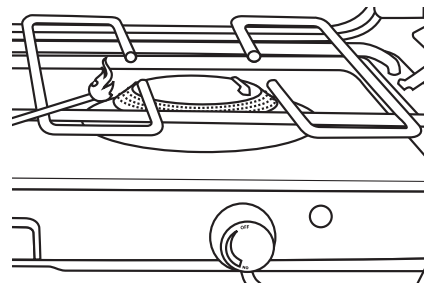

ON / Larger Flame

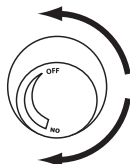

OFF / Smaller Flame

**NOTE:** Observe flame height and color when lit. Flame should have a blue center and yellow tip.

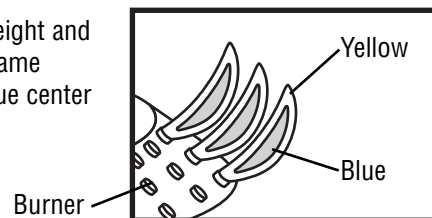

## AFTER-USE SAFETY

- Always allow the stove to cool completely before handling.
- Always disconnect the propane cylinder from stove when not in use - a safety cap should be placed on the propane cylinder.
- Never store propane cylinder in an enclosed area (house, garage, etc.). Store outdoors in a well ventilated, shaded area away from any heat source or open flame.
- Fold wind guards and lid back into their closed position. Unfold legs to lock lid down.

## PROPER CARE & MAINTENANCE

- Wash cooking grill with hot, soapy water, rinse well and dry before storing. Wipe remaining exposed parts of stove with damp cloth. Do not use abrasive materials.
- To protect your stove, the unit must be kept clean and covered at all times when not in use.
- If rust appears on the exterior surface of your stove, clean and buff the affected area with steel wool or fine grit emery cloth. Touch-up with a good quality high-temperature resistant paint.
- Only use replacement/accessory parts manufactured by The Brinkmann Corporation. Repairs should be performed by The Brinkmann Corporation. For parts or repairs, contact The Brinkmann Corporation's Customer Service Department at 800-527-0717.
- Cover and store stove in a protected area away from children and pets.
- After product has been stored and prior to reusing, verify that burners are free from leaves, insects, spider webs, dirt, etc. as these items can obstruct the flow of combustion air.
- Prior to each use, visually check the burner flame for proper operation as described on page 5.  
**DO NOT** use if burner/flame is not operating properly.
- This stove requires an unobstructed airflow to operate correctly.
- During use or storage, always keep the stove area clear and free of combustible materials, gasoline and other flammable vapors and liquids.

**NOTE:** Due to the intense heat from burner, it is normal for paint burn off and discoloration to occur on stove during the first few uses.

©2006 The Brinkmann Corporation  
Dallas, Texas 75244 U.S.A  
www.brinkmann.net

## 1-YEAR LIMITED WARRANTY

For 1-year from date of purchase, The Brinkmann Corporation warrants the Camping Stove against defects due to workmanship or materials to the original purchaser. The Brinkmann Corporation's obligations under this warranty are limited to the following guidelines:

- This warranty does not cover stoves that have been altered or damaged due to: normal wear, abuse, improper maintenance, improper use, disassembly of parts and/or attempted repair by anyone other than an authorized employee of The Brinkmann Corporation.
- This warranty does not cover surface scratching or heat damage to the finish, which is considered normal wear.
- The Brinkmann Corporation may elect to repair or replace damaged units covered by the terms of this warranty.
- This warranty extends to the original purchaser only and is not transferable or assignable to subsequent purchasers.

The Brinkmann Corporation requires reasonable proof of purchase. Therefore, we strongly recommend that you retain your sales receipt or invoice. To obtain replacement parts for your Camping Stove under the terms of this warranty, please call Customer Service Department at 800-527-0717 for a **Return Authorization Number** and further instructions. **A receipt or proof of purchase will be required.** Units returned to Brinkmann (without propane cylinder) must include your name, address and telephone number. Please make sure product is properly packed, postage prepaid and insured. **The Brinkmann Corporation will not be responsible for any products forwarded to us without prior authorization.**

EXCEPT AS ABOVE STATED, THE BRINKMANN CORPORATION MAKES NO OTHER EXPRESS WARRANTY.

THE IMPLIED WARRANTIES OF MERCHANTABILITY AND FITNESS FOR A PARTICULAR PURPOSE ARE LIMITED IN DURATION TO 1-YEAR FROM THE DATE OF PURCHASE. SOME STATES DO NOT ALLOW LIMITATIONS ON HOW LONG AN IMPLIED WARRANTY LASTS, SO THE ABOVE LIMITATION MAY NOT APPLY TO YOU.

ANY LIABILITY FOR INDIRECT, INCIDENTAL OR CONSEQUENTIAL DAMAGES ARISING FROM THE FAILURE OF THE CAMPING STOVE TO COMPLY WITH THIS WARRANTY OR ANY IMPLIED WARRANTY IS EXCLUDED. CUSTOMER ACKNOWLEDGES THAT THE PURCHASE PRICE CHARGED IS BASED UPON THE LIMITATIONS CONTAINED IN THE WARRANTY SET OUT ABOVE. SOME STATES DO NOT ALLOW THE EXCLUSION OR LIMITATION OF INCIDENTAL OR CONSEQUENTIAL DAMAGES, SO THE ABOVE LIMITATION OR EXCLUSION MAY NOT APPLY TO YOU. THIS WARRANTY GIVES YOU SPECIFIC LEGAL RIGHTS, AND YOU MAY ALSO HAVE OTHER RIGHTS WHICH VARY FROM STATE TO STATE.